

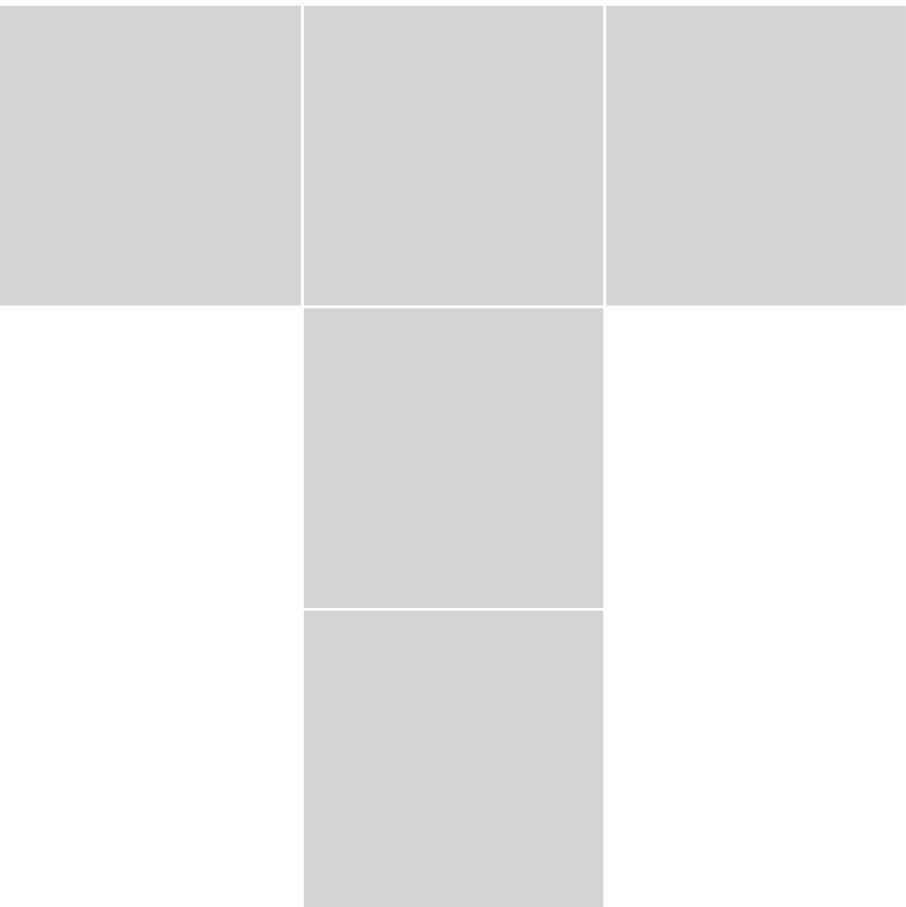

OrthoCube



OrthoCube Wrist System TMW





OrthoCube

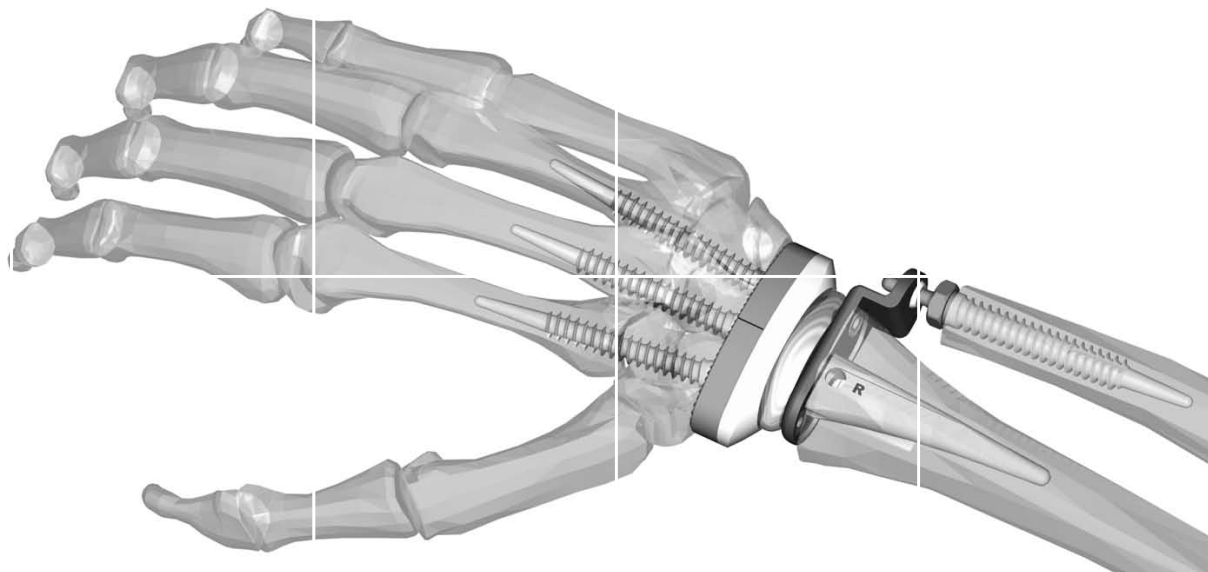

Katalog Handgelenkprothese TMW

Catalog Total Modular Wrist TMW



OrthoCube

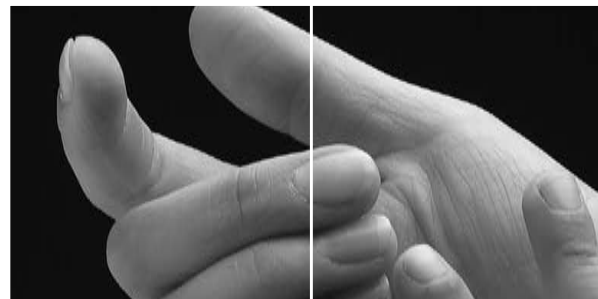
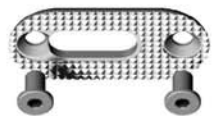

TMW Implantate

Implantate
aus Titan (TiAl6V4)
Titan (TiAl6V4), HA-beschichtet
UHMW Polyethylen
Cobalt-Chrom-Molybdän (Co28Cr6Mo)

TMW Implants

Implants
made of Titanium (TiAl6V4)
Titanium (TiAl6V4), HA-coated
UHMW Polyethylene
Cobalt-Chrom-Molybdän (Co28Cr6Mo)



OrthoCube

Artikel-Nr.	Bezeichnung
25-CIL+0	Carpal Einsatz gross +0
425-CIL+2	Carpal Einsatz gross +2
425-CIL+4	Carpal Einsatz gross +4
425-CIS+0	Carpal Einsatz klein +0
425-CIS+2	Carpal Einsatz klein +2
425-CIS+4	Carpal Einsatz klein +4
425-CILS+0	Carpal Einsatz gross, stabilisiert +0
425-CILS+2	Carpal Einsatz gross, stabilisiert +2
425-CILS+4	Carpal Einsatz gross, stabilisiert +4
425-CISS+0	Carpal Einsatz klein, stabilisiert +0
425-CISS+2	Carpal Einsatz klein, stabilisiert +2
425-CISS+4	Carpal Einsatz klein, stabilisiert +4

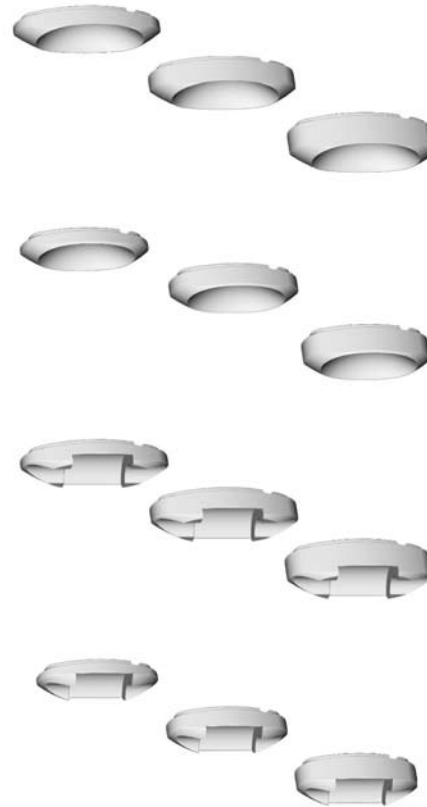

Order no.	Name
425-CIL +0	Carpal Insert large +0
425-CIL+2	Carpal Insert large +2
425-CIL+4	Carpal Insert large +4
425-CIS+0	Carpal Insert small +0
425-CIS+2	Carpal Insert small +2
425-CIS+4	Carpal Insert small +4
425-CILS+0	Carpal Insert large, stabilized +0
425-CILS+2	Carpal Insert large, stabilized +2
425-CILS+4	Carpal Insert large, stabilized +4
425-CISS+0	Carpal Insert small, stabilized +0
425-CISS+2	Carpal Insert small, stabilized +2
425-CISS+4	Carpal Insert small, stabilized +4

TMW Implantate **TMW Implants**





OrthoCube

Artikel-Nr.	Bezeichnung
425-CP-36 425-CP-36-HA	Carpal Platte klein Carpal Platte klein, HA-beschichtet
425-CP-41 425-CP-41-HA	Carpal Platte gross Carpal Platte gross, HA-beschichtet
425-CS-4535-HA	Carpal Schraube 4,5/35mm, HA-beschichtet
425-CS-4550-HA	Carpal Schraube 4,5/50mm, HA-beschichtet
425-CS-5535-HA	Carpal Schraube 5,5/35mm, HA-beschichtet
425-CS-5550-HA	Carpal Schraube 5,5/50mm, HA-beschichtet
425-CS-6535-HA	Carpal Schraube 6,5/35mm, HA-beschichtet
425-CS-6550-HA	Carpal Schraube 6,5/50mm, HA-beschichtet

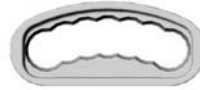

Order no.	Name
425-CP-36 425-CP-36-HA	Carpal Plate small Carpal Plate small, HA-coated
425-CP-41 425-CP-41-HA	Carpal Plate large Carpal Plate large, HA-coated
425-CS-4535-HA	Carpal Screw 4,5/35mm, HA-coated
425-CS-4550-HA	Carpal Screw 4,5/50mm, HA-coated
425-CS-5535-HA	Carpal Screw 5,5/35mm, HA-coated
425-CS-5550-HA	Carpal Screw 5,5/50mm, HA-coated
425-CS-6535-HA	Carpal Screw 6,5/35mm, HA-coated
425-CS-6550-HA	Carpal Screw 6,5/50mm, HA-coated

TMW Implantate

TMW Implants





OrthoCube

Artikel-Nr.	Bezeichnung
425-US-5550-HA	Ulnar Schraube 5,5x50mm, HA-beschichtet
425-US-6550-HA	Ulnar Schraube 6,5x50mm, HA-beschichtet
425-UES-5550-HA	Ulnar Endschraube 5,5x50mm, HA-beschichtet
425-UES-6550-HA	Ulnar Endschraube 6,5x50mm, HA-beschichtet



Order no.	Name
425-US-5550-HA	Ulnar Screw 5,5x50mm, HA-coated
425-US-6550-HA	Ulnar Screw 6,5x50mm, HA-coated
425-UES-5550-HA	Ulnar End-Screw 5,5x50mm, HA-coated
425-UES-6550-HA	Ulnar End-Screw 6,5x50mm, HA-coated

425-DW-5502	Distanz Ring 5,5x2mm
425-DW-5503	Distanz Ring 5,5x3mm
425-DW-6502	Distanz Ring 6,5x2mm
425-DW-6503	Distanz Ring 6,5x3mm



425-DW-5502	Distance Washer 5,5x2mm
425-DW-5503	Distance Washer 5,5x3mm
425-DW-6502	Distance Washer 6,5x2mm
425-DW-6503	Distance Washer 6,5x3mm

TMW Implantate

TMW Implants





OrthoCube

Artikel-Nr.	Bezeichnung
425-P	Platte
425-P-HA	Platte, HA-beschichtet
425-UP	Ulnar Platte
425-UP-HA	Ulnar Platte, HA-beschichtet
425-UJ	Ulnar Joint Insert
425-CSS	Senkschraube M3

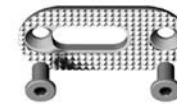

Order no.	Name
425-P	Plate
425-P-HA	Plate, HA-coated
425-UP	Ulnar Plate
425-UP-HA	Ulnar Plate, HA-coated
425-UJ	Ulnar Joint Insert
425-CSS	Countersunk Screw M3

TMW Implantate

TMW Implants

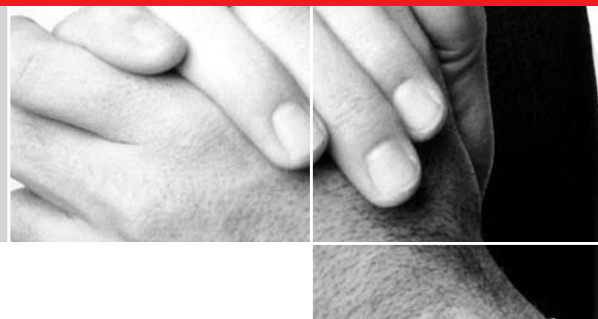



OrthoCube

Artikel-Nr.	Bezeichnung
425-STL-HA / 425-PP-S	Schaft lang, HA beschichtet, mit Proximal-Teil, stabilisiert
425-STL / 425-PP-S	Schaft lang, mit Proximal-Teil, stabilisiert
425-ST-HA / 425-PP-S	Schaft, HA beschichtet, mit Proximal-Teil, stabilisiert
425-ST / 425-PP-S	Schaft, mit Proximal-Teil, stabilisiert
425-STL-HA / 425-PP-U	Schaft lang, HA beschichtet, mit Proximal-Teil
425-STL / 425-PP-U	Schaft lang, mit Proximal-Teil
425-ST-HA / 425-PP-U	Schaft, HA beschichtet, mit Proximal-Teil
425-ST / 425-PP-U	Schaft, mit Proximal-Teil



Order no.	Name
425-STL-HA / 425-PP-S	Stem long, HA coated, with Proximal Part, stabilized
425-STL / 425-PP-S	Stem long, with Proximal Part, stabilized
425-ST-HA / 425-PP-S	Stem, HA coated, with Proximal Part, stabilized
425-ST / 425-PP-S	Stem, with Proximal Part, stabilized
425-STL-HA / 425-PP-U	Stem long, HA coated, with Proximal Part
425-STL / 425-PP-U	Stem long, with Proximal Part
425-ST-HA / 425-PP-U	Stem, HA coated, with Proximal Part
425-ST / 425-PP-U	Stem, with Proximal Part

TMW Implantate

TMW Implants



OrthoCube

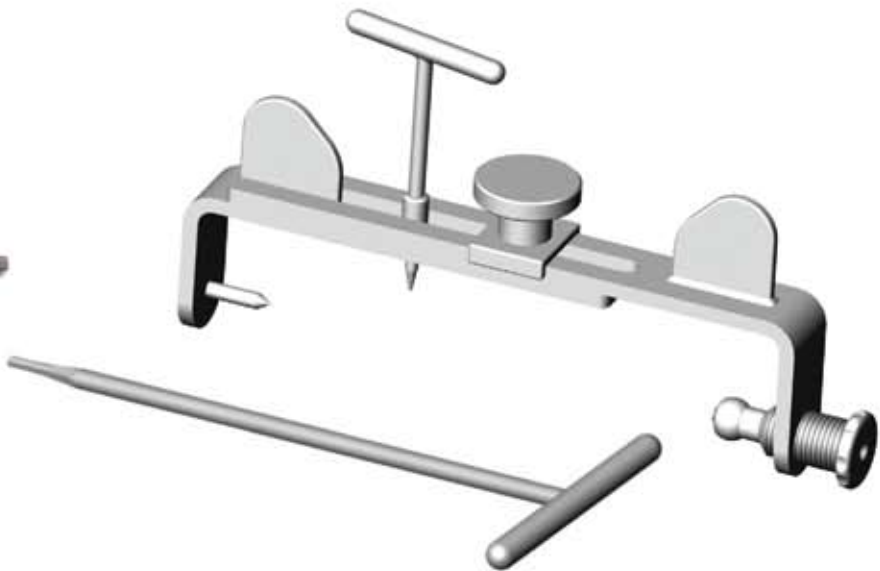
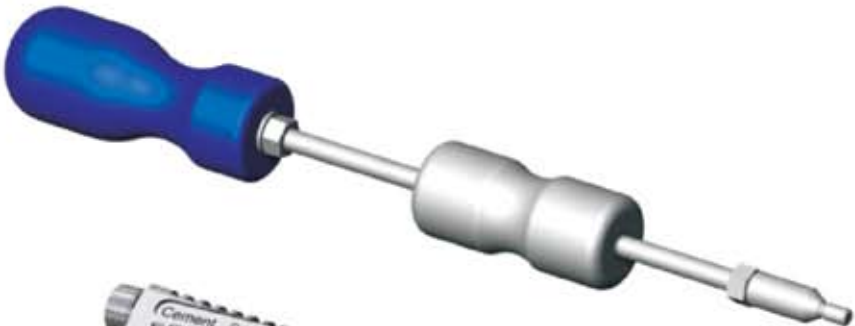

TMW Instrumente

TMW Instruments

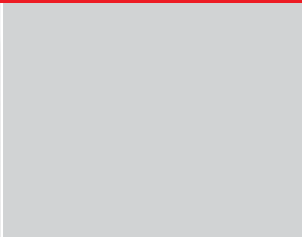



OrthoCube

Artikel-Nr.	Bezeichnung	
450-CB	Schnittschablone	
450-WG	Zielinstrument	
450-KW13	Kirschnerdraht 1,3mm	
450-D27	Kannulierter Bohrer 2,7mm	
450-D40	Kannulierter Bohrer 4.0mm	
450-AC	Winkellehre	

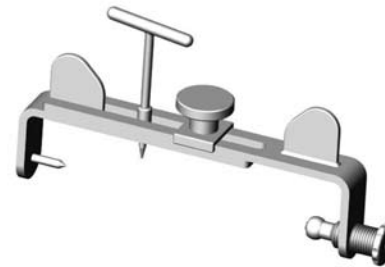
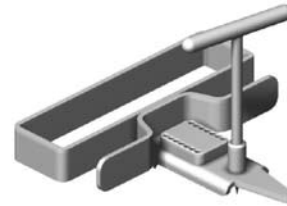
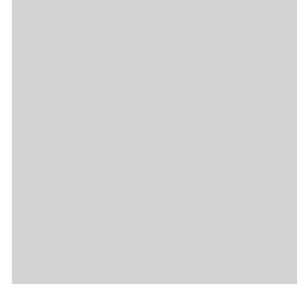

Order no.	Name	
450-CB	Cutting Block	
450-WG	Wire Guide	
450-KW13	K-Wire 1.3mm	
450-D27	Cannulated Drill 2.7mm	
450-D40	Cannulated Drill 4.0mm	
450-AC	Angle Check	

TMW Instrumente

TMW Instruments



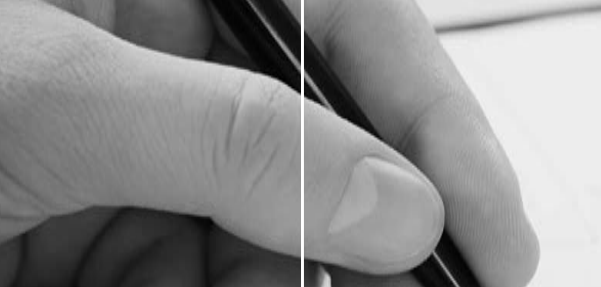

OrthoCube

Artikel-Nr.	Bezeichnung
450-SB+0 450-HANDLE01	Abstandslehre blau Griff
450-SB+2 450-HANDLE01	Abstandslehre grün Griff
450-SB+4 450-HANDLE01	Abstandslehre rot Griff
250-103	Multigriff
250-100/10/3,5	Innensechskantschlüssel 3,5mm
450-USD	Ulnar Schraubendreher
450-HD 20	Innensechskantschlüssel 2mm



Order no.	Name
450-SB+0 450-HANDLE01	Spacer Block blue Handle
450-SB+2 450-HANDLE01	Spacer Block green Handle
450-SB+4 450-HANDLE01	Spacer Block red Handle
250-103	Multi Grap Handle
250-100/10/3,5	Hex Key Driver 3.5mm
450-USD	Ulnar Screw Driver
450-HD 20	Hex Driver 2mm

TMW Instrumente

TMW Instruments



OrthoCube

Artikel-Nr.	Bezeichnung
450-BI	Raspel Ein-/Ausschläger
450-R	Raspel
450-R-HA	Raspel für HA-beschichteten Schaft
450-TS	Probeschaft
450-TSS	Probeschaft stabilisiert
450-TSL 450-TSLS	Probeschaft lang (*) Probeschaft lang stabilisiert(**)
450-SI	Schafteinschläger
450-SIS	Schafteinschläger stabilisiert
450-RG 450-RR	Radius-Lehre Radius-Räumer

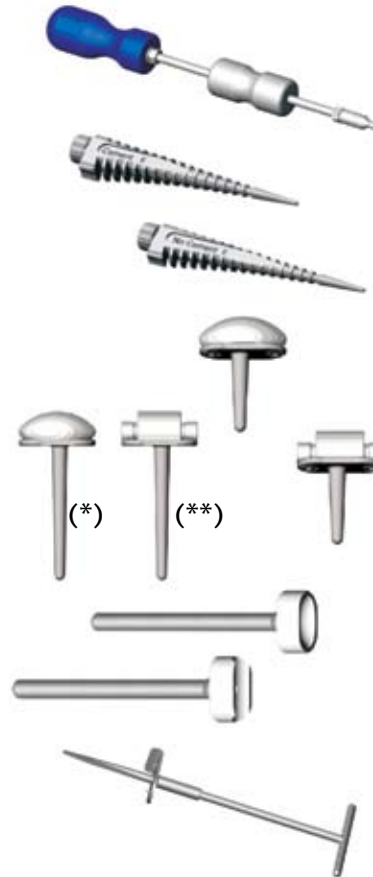

Order no.	Name
450-BI	Broach Impactor/Extractor
450-R	Broach
450-R-HA	Broach for HA coated Stem
450-TS	Trial Stem
450-TSS	Trial Stem stabilized
450-TSL 450-TSLS	Trial Stem long(*) Trial Stem long stabilized (**)
450-SI	Stem Impactor
450-SIS	Stem Impactor stabilized
450-RG 450-RR	Radial Guide Radial Reamer

TMW Instrumente



TMW Instruments



OrthoCube

Artikel-Nr.	Bezeichnung
450-CIL-T+0	Carpal Test Insert, gross +0
450-CIL-T+2	Carpal Test Insert, gross +2
450-CIL-T+4	Carpal Test Insert, gross +4
450-CILS-T+0	Carpal Test Insert, gross, stabilisiert +0
450-CILS-T+2	Carpal Test Insert, gross, stabilisiert +2
450-CILS-T+4	Carpal Test Insert, gross, stabilisiert +4
450-CIS-T+0	Carpal Test Insert, klein +0
450-CIS-T+2	Carpal Test Insert, klein +2
450-CIS-T+4	Carpal Test Insert, klein +4
450-CISS-T+0	Carpal Test Insert, klein, stabilisiert +0
450-CISS-T+2	Carpal Test Insert, klein, stabilisiert +2
450-CISS-T+4	Carpal Test Insert, klein, stabilisiert +4

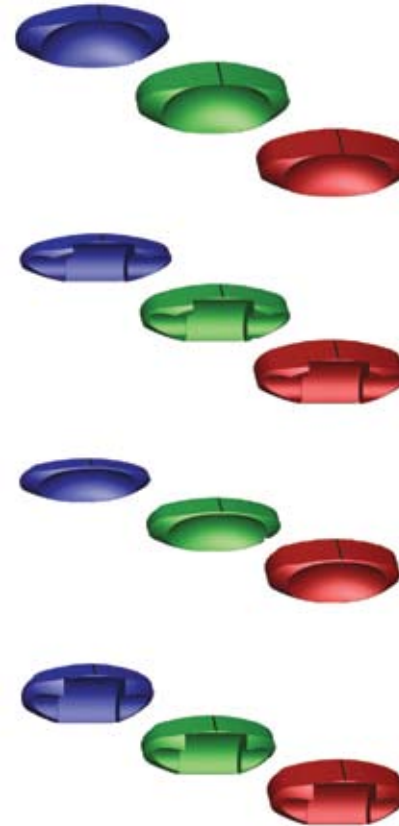

Order no.	Name
450-CIL-T+0	Carpal Test Insert, large +0
450-CIL-T+2	Carpal Test Insert, large +2
450-CIL-T+4	Carpal Test Insert, large +4
450-CILS-T+0	Carpal Test Insert, large, stabilized +0
450-CILS-T+2	Carpal Test Insert, large, stabilized +2
450-CILS-T+4	Carpal Test Insert, large, stabilized +4
450-CIS-T+0	Carpal Test Insert, small +0
450-CIS-T+2	Carpal Test Insert, small +2
450-CIS-T+4	Carpal Test Insert, small +4
450-CISS-T+0	Carpal Test Insert, small, stabilized +0
450-CISS-T+2	Carpal Test Insert, small, stabilized +2
450-CISS-T+4	Carpal Test Insert, small, stabilized +4

TMW Instrumente



TMW Instruments



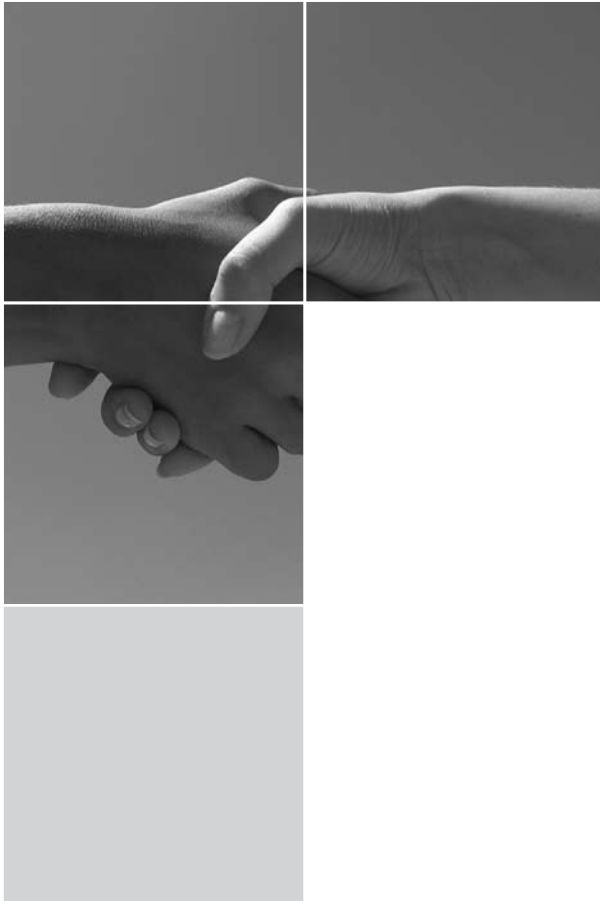

OrthoCube

Kontakt

Hauptsitz/Vertrieb - Headquarters/Sales:
OrthoCube AG
Neuhofstrasse 1
CH-6340 Baar
Fon +41 (0) 41 760 74 14
Fax +41 (0) 41 760 74 15
info@orthocube.com
www.orthocube.com

OrthoCube GmbH
Heinkelstrasse 41
D-71384 Weinstadt
Fon +49 (0) 7151 994 77 70
Fax +49 (0) 7151 994 77 72
info@orthocube.com
www.orthocube.com

Contact

Artikelnr./Product Code K-07111IV1